

Pocketalker® 2.0

Personal Amplifier Model PKT 2.0

USER MANUAL



Contents

Safety Warnings	3
Overview	5
Included Items.....	5
Getting Started.....	6
Recharging NiMH Batteries	10
Listening during conversations with others	11
Extending the Microphone.....	12
Using an Optional Neckloop	13
Using the Lanyard	14
LED Indicators.....	16
Hints & Tips.....	17
Pocketalker® 2.0 Specifications	18
Limited Warranty	19

Safety Warnings

CAUTION!

The Pocketalker is capable of producing very loud sound levels. To prevent sound levels greater than 130dB that can potentially damage hearing with long-term exposure, use only earphones and headphones supplied by Williams Sound. The Williams Sound Headphone model HED 026 should not be used with the Pocketalker as it can produce sound levels greater than 130dB.

CAUTION!

This product is designed to amplify sounds to a high volume level which could potentially cause hearing damage if used improperly. **To protect your hearing and the hearing of others:**

1. Make sure the volume is turned down before putting on the earphone or headphone. While wearing the earphone or headphone, adjust the volume to a comfortable level.
2. Set the volume level at the minimum setting that you need to hear.
3. If you experience feedback (a squealing or howling sound), reduce the volume setting and move the microphone away from the earphone or headphone.

Do not allow children **or other unauthorized persons** to have access to this product.

WARNING!

1. Do not use this apparatus near water.
2. Clean only with a damp cloth. Do not use alcohol or any other type of cleaner.
3. Do not use near any heat sources such as radiators, heat registers, stoves, or other apparatus that produce heat.
4. Use only attachments/accessories specified by the manufacturer.
5. Do not use the product with a neckloop in areas where the neckloop could get pulled or caught in a machine.

SERVICING OR ATTEMPTING TO SERVICE THIS DEVICE WILL VOID THE WARRANTY.

Refer servicing to qualified personnel. Servicing is required when the unit has been damaged in any way; if liquid has been spilled into the unit, it has been exposed to rain or moisture, does not operate normally, or has been dropped.

POWER SUPPLY SAFETY WARNINGS:

1. Never charge the unit in enclosed spaces such as handbags, cases, or other closed storage bags.
2. Unplug this device during lightning storms, or when charging is complete and the device is unused for long periods of time.
3. Be advised that different operating voltages require the use of different types of line cord attachment plugs. Check the line voltage in your area and use the correct type.
4. Use only the power supply provided by the manufacturer of this device. Other power supplies may have similar specifications, but may not be equivalent. Use of an unapproved power supply may leave the device partially or completely inoperable, and will void the warranty.
5. Protect the power cord from being walked on or pinched, particularly at plugs, receptacles, and near the power jack on the unit.

FOR CUSTOMERS IN THE UNITED STATES

This equipment has been tested and found to comply with the limits for Class A digital device, pursuant to part 15 of the FCC rules.

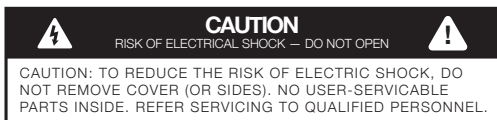

FOR CUSTOMERS IN CANADA

This Class A digital device meets all requirements of the Canadian Interference-Causing Equipment Regulations.

Cet appareil numérique de la classe A respecte toutes les exigences du Règlement sur le matériel brouilleur du Canada.



Overview

The Pocketalker® 2.0 is a versatile, high quality assistive listening device designed to improve communications in difficult listening situations. The Pocketalker delivers clear, distinct sound, while its large, manageable controls provide for easy operation.

Use the Pocketalker to improve listening on a one-to-one basis, in small group situations, while listening to your favorite TV or radio programs, or while riding in the car.

The Pocketalker is not sold, advertised, or intended for use as a personal hearing aid. Williams Sound recommends that any individual experiencing hearing loss be examined by a physician/audiologist to determine the cause before using an amplification device like the Pocketalker.

The Pocketalker is offered with rechargeable options.

Call Williams Sound for more information at 1-800-328-6190.

Included Items

- (1) PKT 2.0 Personal Amplifier
- (1) BAT 010-2 Two AAA Batteries
- (1) MIC 014-R Plug-Mount Microphone, Omnidirectional
- (1) EAR 042 Dual Stereo Isolation Earphones
- (1) HED 024 Stereo Headphones
- (1) RCS 003 Lanyard
- (1) WCA 007 WC 3.5 mm male to 3.5 mm female cable with mounting clips (12 ft)

Getting Started

1. Open the battery cover: Using your thumb, apply firm pressure on the ridges of the cover and slide it down and away from the Pocketalker.
2. Switch the **Battery Type Switch** to the position for the battery type that will be used (**NiMH** or **Alkaline**).

Battery Installation

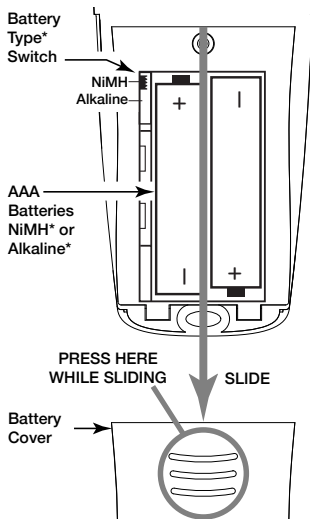

***NOTE: If using rechargeable NiMH AAA batteries, the battery switch MUST be switched to the NiMH position to allow charging!**

3. Press 2 AAA batteries into place in the battery compartment, being careful to observe correct placement of (+) and (-) terminals.
4. Your Pocketalker system is supplied with the headphone and earphone for best performance. Williams Sound offers additional options - visit www.williamssound.com.

! WARNING! Do not attempt to charge Alkaline batteries!

Headphone/Earphone Jack

Pocketalker® 2.0: Left Side View

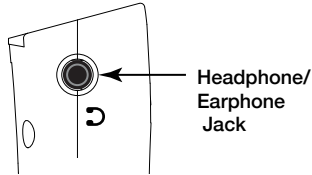

5. Wear the earphone or headphone so it fits comfortably.
6. Adjust the balance for the type of headphone or earphone being used. Using a small screwdriver, turn left (or right) to increase (or decrease) the volume level on the left or right side of the headphones.

Note: If using a single/mono headphone/earphone or a neckloop, turn the balance fully left (counter-clockwise) - this will maximize volume and help to maximize battery life.

Balance Adjustment - Single/Dual Earphones

Pocketalker® 2.0: Battery Compartment

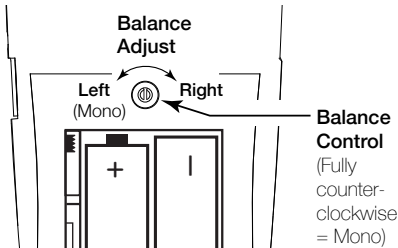

7. Close the battery compartment cover: align the cover on the back of the unit and slide it upwards until it snaps into place.
8. Optional: If the external microphone (MIC 014-R) will be used, plug it into the External Microphone Jack on the top of the unit.

Microphone Use / Installation

Pocketalker® 2.0: Top View

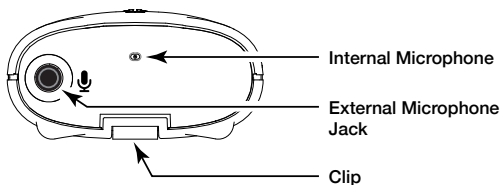

- Turn ON the Pocketalker by rolling the “Power On/Off Volume Adjust” rotary dial (located on the front) towards the top. The power “on” green LED indicator on the front of the unit should light up. As you rotate the knob further towards the top, the volume will get louder.

Power On / Volume Adjustment Dial

Pocketalker® 2.0: Front View

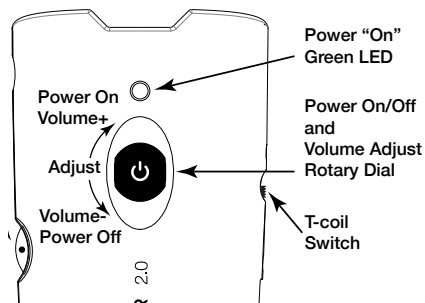

- Adjust the volume up or down according to your preferences by rotating the volume dial towards the top (for more volume) or towards the bottom (for less volume).

NOTE: The Power “On” Green LED will blink fast when the battery is low.

11. Adjust the tone according to your preferences. Turning the tone control towards the top (+) boosts the treble (high frequency). Turning the tone control towards the bottom (-) boosts the bass (low frequency). The white dot on the dial indicates the normal position (no treble or bass boost).

Tone Adjustment Dial

Pocketalker® 2.0: Left Side View

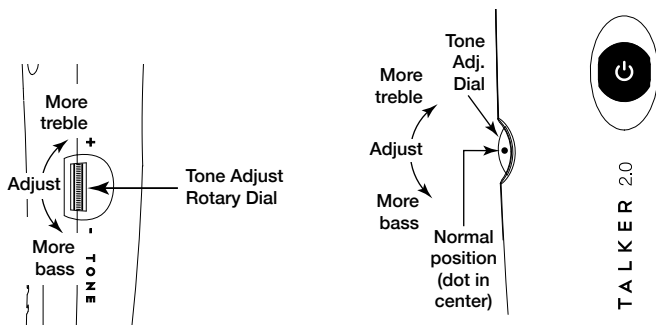

Using the built-in T-coil with a Loop System

The Pocketalker can be used with loop systems. When the T-coil switch on the Pocketalker is enabled, the Pocketalker disables the microphone input, picks up the loop signal, and sends the audio through the headphone jack.

To use this feature:

Follow the “Getting Started” instructions and *instead* of step 8, flip the T-coil switch to the “T-coil” position (up towards the T-coil symbol). The T-coil “On” LED indicator above the switch will light up.

Internal T-Coil Switch and Indicator LED

Pocketalker: Right Side View

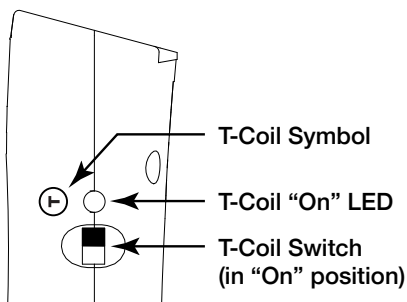

Note: For best performance when using the t-coil feature, the Pocketalker must be in a **vertical** orientation. This ensures the best magnetic coupling to the loop system.

Recharging NiMH Batteries

The Pocketalker can recharge NiMH batteries when used with an optional BAT KT7 (US) or BAT KT8 (International) charging kit.

1. Verify or change battery switch to the NiMH position.
2. Verify or insert NiMH batteries into battery compartment.
3. Using the included USB A to USB Micro-B cable, plug the USB Micro-B end into the USB Micro-B charging port on the Pocketalker. Plug the USB A end into the USB A port on the power supply included with the charging kit. Plug the power supply into a wall outlet.
4. The charging indicator will blink slow while charging, and then will stay on solid when the unit is charged.

! **WARNING!** Do not attempt to charge Alkaline batteries!

Charging Connections

Pocketalker and BAT KT7 (US) Charging Kit

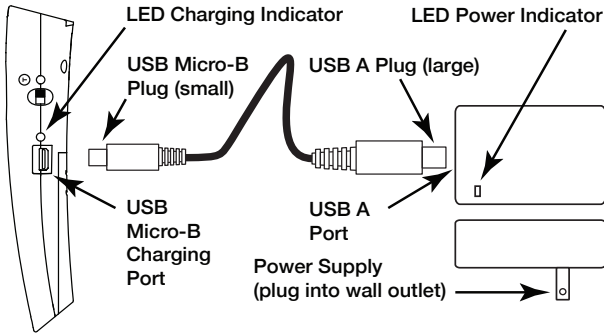

Listening during conversations with others

The Pocketalker picks up sounds and boosts them according to the volume you've set. For best results, place or hold the Pocketalker's microphone as close as possible to the person who is speaking.

Seated

Many users set the Pocketalker on a table if they're in a restaurant or small group situation. Aim the microphone in the direction of the person speaking.

Standing Or Walking

Many users use the Pocketalker "Clip" and attach it to their pocket, pants or skirt. The lanyard may also be used (see section "Using the Lanyard").

In The Car

For conversations in the car, you can use the External Microphone (MIC 014-R) with the optional 3.5 mm - 3.5 mm Microphone Extension Cord (WCA 007 WC) and optional Lapel Clip (CLP 014) to attach the microphone to the shirt or blouse of your fellow rider (see "Extending the Microphone").

Extending the Microphone

When the Pocketalker's internal microphone is too far away from the desired sound to be effective, the optional 12 ft, 3.5 mm - 3.5 mm extension cord kit (WCA 007 WC) can be used to extend an external microphone to a television or another person.

To extend the Microphone:

1. Plug the external microphone into the female end of the extension cord. Arrange the cord to reach the loudspeaker of the TV or other person. Plug the male end of the extension cord into the microphone jack on the Pocketalker.

Using the 3.5mm Extension Cord

Pocketalker: Front View

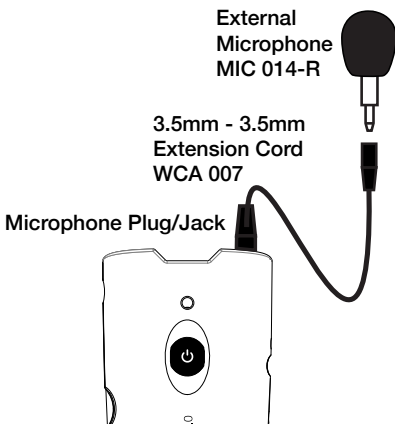

2. For a TV: Attach one of the plastic clips (two PLC 004 clips are included with the WCA 007 WC kit) to the TV, near the loudspeaker, as shown in the illustration.
3. For a TV: Press the microphone into the plastic clip.
4. For a TV: Turn on the TV and the Pocketalker. Adjust the volume

on both as needed.

5. If attaching the microphone to another person, ask them to begin speaking and adjust the volume as necessary.

Placement of Mic Clip on TV

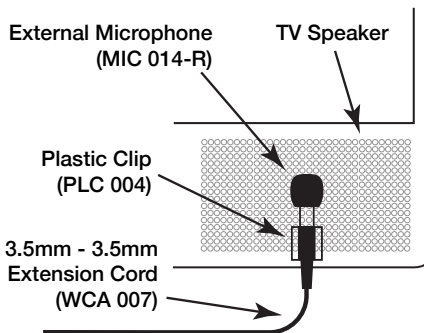

Using an Optional Neckloop

Williams Sound's optional neckloop (NKL 001) can be used with the Pocketalker in situations where the Pocketalker is needed, and the user has a hearing aid with a T-coil.

How it works: The Pocketalker picks up the sound with the internal or external microphone, and sends it into the neckloop. The neckloop magnetically couples with the T-coil in the listener's hearing aid(s). With the hearing aid T-coil switch on, the listener can hear the sound directly in their hearing aid(s).

To use the neckloop: Place the neckloop around your neck as shown below. While holding the housing with one hand, pull up on the cord lock bead with the other hand to tighten for comfort. Plug the neckloop into the headphone jack on the Pocketalker. Turn on the T-coil in the hearing aid(s). Turn on the Pocketalker and adjust the volume to a comfortable listening level.

Using a Neckloop

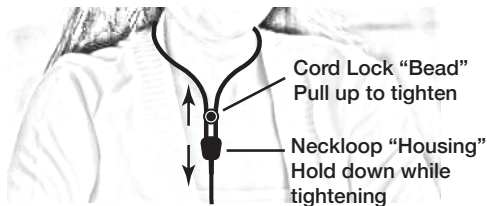

Using the Lanyard

The supplied Pocketalker Lanyard (RCS 003) provides a convenient way of transporting the Pocketalker from place to place; it protects your investment from accidental dropping, and provides quick and easy access for operation whenever it is needed. Wear the lanyard around your neck.

**Operating the
Pocketalker
worn hanging
around the
neck with
the supplied
Pocketalker
Lanyard**



Installing the Lanyard (RCS 003)

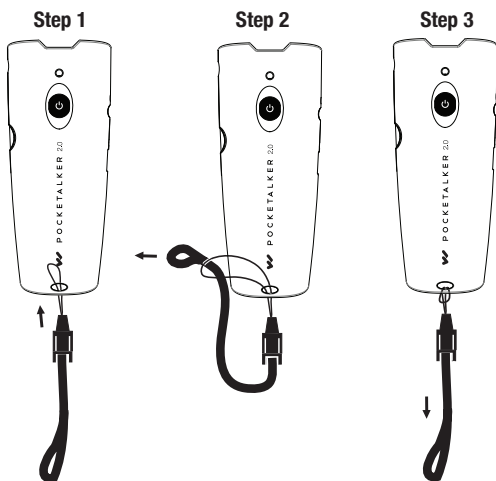

The RCS 003 Lanyard has a safety breakaway feature that disconnects when too much tension is applied to the lanyard.

LED Indicators

Power LED	Charge LED	T-Coil LED	Condition Indicated
On	Off		Operating normally; battery level sufficient
Fast blinks	Off		Battery is low
	Slow blinks		Battery is charging
	On (charger plugged in)		Battery charging complete
	Off (charger plugged in)		No batteries detected or charger not detected
		On	T-coil in use ; internal and external mic jack disabled
		Off	T-coil not in use ; internal mic enabled (or external mic if plugged in)
Off	Off		Battery too low to operate
	Fast blinks		Batteries are too low to charge. Pocketalker is attempting to recondition batteries. If fast blinks persist for more than 2 hours, batteries are bad; replace with new batteries. If recondition attempt is successful, Charge LED will change to slow blinks, indicating that normal charging is now occurring.

LED Indicators Blink Rates

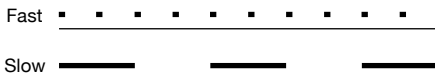



Fast = 4 blinks every 2 seconds

Slow = 1 blink every 2 seconds

Hints & Tips

The Pocketalker has been designed to be as easy to use as possible. However, if you have trouble, check the following:

1. If using an external microphone, make sure the microphone is plugged into the “External Mic” jack  and the T-Coil switch is set to “Off”. Make sure the earphone or headphone is plugged into the “Headphone” jack . If using the T-Coil on the Pocketalker, make sure the T-Coil Switch is on and verify that the T-Coil indicator LED is lit.
2. Make sure the batteries are not depleted and have been inserted (observing correct polarity \pm) into the battery compartment.
3. If using rechargeable batteries, make sure the batteries are sufficiently charged and that the battery switch is set appropriately.
4. If you experience a howling or squealing sound, this is called feedback. Depending on the earphone or headphone used, you can sometimes get feedback when the volume control is turned higher than 3 or $3\frac{1}{2}$.

To reduce feedback, turn down the volume, or move the microphone (internal or external) farther away from the earphone or headphone.

Also, try turning the Tone Control down (counter-clockwise) to reduce the high frequency.

5. The Pocketalker headphone jack is a stereo jack, designed for use with stereo earphones or headphones. However, if you use *mono* earphones or headphones with the Pocketalker, turn the balance control (located in the battery compartment) fully to the left, or “mono” position. While this maximizes volume, this will also help in maximizing battery life.
6. Observe what the LED indicators on the unit are doing:
 - Power ON LED** (on front)
 - Charging LED** (on right side)
 - T-Coil LED** (on right side)

See the chart under “LED Indicators” to determine unit status and problem resolution.
7. If the steps above don’t solve the problem, contact your Williams Sound Dealer for further instructions.

Pocketalker® 2.0 Specifications

Personal amplifier Model PKT 2.0

Dimensions:	4.9" L x 2.0" W x 1.0" H. (124mm x 51mm x 25mm) (Not including clip or microphone assembly)
Weight:	3.1 oz. (88 grams) (with batteries)
Color/material:	White ABS/Polycarbonate molded plastic case.
Battery Type:	Two 1.5V (AAA size), Alkaline or NiMH rechargeable* (Williams Sound BAT 010-2 Alkaline or BAT 022-2 NiMH recommended)
Battery Life:	Up to 105 hours (typical usage) with the BAT 010-2. Low Battery Indicator: Power "On" Green light on front panel flashes.
**NiMH battery Charging:	Charging: 16 hours with BAT 022-2. Red LED blinks when charging. End of Charge: Red LED is on solid. At end of charge, maintenance charge is provided. NOTE: Charging requires optional charging kit BAT KT7 or BAT KT8.
Microphone:	Internal , omnidirectional MEMS microphone (micro-electro-mechanical system). Optional External , omnidirectional, plug-in electret microphone with foam windscreens and 3.5mm mono plug (MIC 014-R).
T-Coil:	Internal with on/off switch and LED indicator.
Tone Control:	External rotary control knob allows user to adjust high/low frequency to optimize hearing.
***Balance Control:	Adjusts Left/Right Volume Balance
Power/Volume Control:	External rotary volume control knob with integrated power ON-OFF switch.
Microphone Jack:	3.5 mm, stereo mini plug. Tip=Mic signal, Ring=NC, Sleeve=Gnd.
Headphone Jack:	3.5 mm, stereo mini plug. Tip=Left/Mono, Ring=Right, Sleeve=Gnd.
Optional Accessories:	Clip: CLP 014; Allows the user to clip MIC 014 to clothing such as a lapel or shirt pocket. Lanyard: RCS 003; Allows user to wear unit around the neck, or as a wrist strap. 3.5mm-3.5mm Extension Cord: WCA 007 WC; extends an external microphone to 12 ft. Stereo Earphones / Headphones / Neckloop: EAR 042 / HED 024, HED 036 / NKL 001-S (stereo) Neckloop Mono Earphones / Headphones / Neckloop***: EAR 013, EAR 008, EAR 022, EAR 041 / HED 021, HED 027 / NKL 001 (mono) Neckloop Charging Kits: BAT KT7 (US), BAT KT8 (International)
Approvals:	RoHS, WEEE, FCC, IC
Warranty:	5 years, parts and labor (90 days on accessories)

Electrical Specifications (1 kHz Sine Wave reference) Typical

Power output:	52 mW (max) into 32 ohms (Stereo)
ALC:	Automatic Level Control; Limits maximum output level
Distortion:	1% THD (max)
Max gain:	63 dB @ 2.5 kHz (Tone=High)

Frequency response

Tone Control at high position:	2.7dB boost at 5 kHz, 6.7dB cut at 400 Hz.
Tone Control at mid position:	0.6dB cut at 5 kHz, 2.9dB cut at 400 Hz.
Tone Control at low position:	2.0dB cut at 5 kHz, 3.0dB boost at 400 Hz.

*Battery switch must be in correct position for battery type being used.

**Charging requires optional charging kit BAT KT7 (USA) or BAT KT8 (International).

***When using **mono** earphones, headphones or neckloop, the balance control on the Pocketalker must be turned fully counter-clockwise (to the "mono" position) for best volume and battery life.

Note: The Pocketalker is not sold, advertised, or intended for use as a personal hearing aid. Williams Sound recommends that any individual experiencing hearing loss be examined by a physician/audiologist to determine the cause before using an amplification device such as the Pocketalker.

Acoustic Specifications for Headphones recommended for use with the Pocketalker are published on our website.

Limited Warranty

Williams Sound products are engineered, designed and manufactured under carefully controlled conditions to provide you with many years of reliable service. Williams Sound warrants the Pocketalker PKT 2.0 Personal Amplifier against defects in materials and workmanship for FIVE (5) years. During the first five years from the purchase date, we will promptly repair or replace the Pocketalker PKT 2.0 Personal Amplifier.

Microphones, earphones, headphones, batteries, cables, carry cases, and all other accessory products carry a 90-day warranty. Neckloops carry a 1-year warranty.

WILLIAMS SOUND HAS NO CONTROL OVER THE CONDITIONS UNDER WHICH THIS PRODUCT IS USED. WILLIAMS SOUND, THEREFORE, DISCLAIMS ALL WARRANTIES NOT SET FORTH ABOVE, BOTH EXPRESS AND IMPLIED, WITH RESPECT TO THE Pocketalker® 2.0 AMPLIFIER, INCLUDING BUT NOT LIMITED TO, ANY IMPLIED WARRANTY OF MERCHANTABILITY OR FITNESS FOR A PARTICULAR PURPOSE. WILLIAMS SOUND SHALL NOT BE LIABLE TO ANY PERSON OR ENTITY FOR ANY MEDICAL EXPENSES OR ANY DIRECT, INCIDENTAL OR CONSEQUENTIAL DAMAGES CAUSED BY ANY USE, DEFECT, FAILURE OR MALFUNCTION OF THE PRODUCT, WHETHER A CLAIM FOR SUCH DAMAGES IS BASED UPON WARRANTY, CONTRACT, TORT OR OTHERWISE. THE SOLE REMEDY FOR ANY DEFECT, FAILURE OR MALFUNCTION OF THE PRODUCT IS REPLACEMENT OF THE PRODUCT. NO PERSON HAS ANY AUTHORITY TO BIND WILLIAMS SOUND TO ANY REPRESENTATION OR WARRANTY WITH RESPECT TO THE Pocketalker® 2.0. UNAUTHORIZED REPAIRS OR MODIFICATIONS WILL VOID THE WARRANTY.

The exclusions and limitations set out above are not intended to, and should not be construed so as to contravene mandatory provisions of applicable law. If any part or term of this Disclaimer of Warranty is held to be illegal, unenforceable or in conflict with applicable law by a court of competent jurisdiction, the validity of the remaining portions of this Disclaimer of Warranty shall not be affected, and all rights and obligations shall be construed and enforced as if this Limited Warranty did not contain the particular part or term held to be invalid.



10300 Valley View Rd • Eden Prairie, MN 55344
800-843-3544 / 952-943-2252 • FAX: 952-943-2174
Website: www.williamssound.com
Email: info@williamssound.com